

Article number: 20992V25M10

Description: E+G Threaded end-caps - GN 992-V25-M10

## Measures

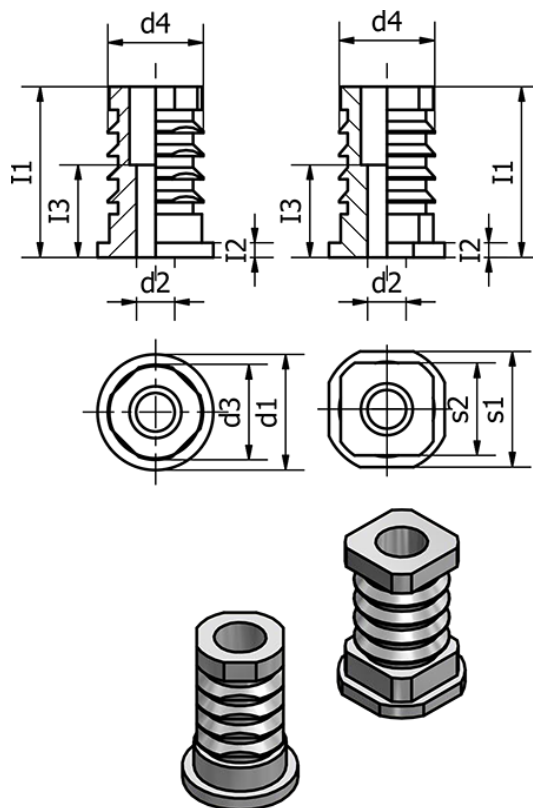

d1 =	s2 = 21
d2 = 10	Weight (g) = 22
d3 =	
d4 = 21.5	
I1 = 33.5	
I2 = 2.5	
I3 = 16	
s1 = V25	